

## 100V N-Ch Power MOSFET

### Feature

- ◇ High Speed Power Switching, Logic Level.
- ◇ Enhanced Body diode dv/dt capability
- ◇ Enhanced Avalanche Ruggedness
- ◇ 100% UIS Tested, 100% Rg Tested
- ◇ Lead Free, Halogen Free

$V_{DS}$		100	V
$R_{DS(on),typ}$	$V_{GS}=10V$	16.5	mΩ
$R_{DS(on),typ}$	$V_{GS}=4.5V$	20.6	mΩ
$I_D$		8	A

### Application

- ◇ Synchronous Rectification in SMPS
- ◇ Hard Switching and High Speed Circuit
- ◇ DC/DC in Telecoms and Industrial

SOIC-8

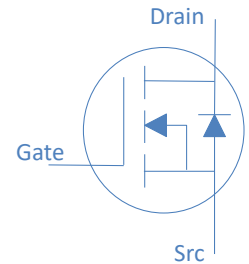
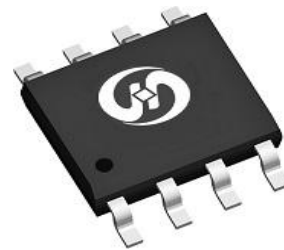

Part Number	Package	Marking
HGS220N10SL	SOIC-8	GS220N10SL

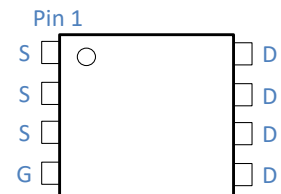

### Absolute Maximum Ratings at $T_j=25^{\circ}C$ (unless otherwise specified)

Parameter	Symbol	Conditions	Value	Unit
Continuous Drain Current	$I_D$	$T_C=25^{\circ}C$	8	A
		$T_C=100^{\circ}C$	6.2	
Drain to Source Voltage	$V_{DS}$	-	100	V
Gate to Source Voltage	$V_{GS}$	-	$\pm 20$	V
Pulsed Drain Current	$I_{DM}$	-	34	A
Avalanche Energy, Single Pulse	$E_{AS}$	$L=0.1mH, T_C=25^{\circ}C$	12	mJ
Power Dissipation	$P_D$	$T_C=25^{\circ}C$	3.1	W
Operating and Storage Temperature	$T_J, T_{stg}$	-	-55 to 150	$^{\circ}C$

### Absolute Maximum Ratings

Parameter	Symbol	Max	Unit
Thermal Resistance Junction-Lead	$R_{\theta JL}$	25	$^{\circ}C/W$
Thermal Resistance Junction-Ambient ( $t \leq 10s$ )	$R_{\theta JA}$	40	$^{\circ}C/W$
Thermal Resistance Junction-Ambient (steady state)		75	$^{\circ}C/W$

**Electrical Characteristics at  $T_J=25^{\circ}\text{C}$  (unless otherwise specified)**
**Static Characteristics**

Parameter	Symbol	Conditions	Value			Unit
			min	typ	max	
Drain to Source Breakdown Voltage	$V_{(BR)DSS}$	$V_{GS}=0V, I_D=250\mu A$	100	-	-	V
Gate Threshold Voltage	$V_{GS(th)}$	$V_{GS}=V_{DS}, I_D=250\mu A$	1.4	2.0	2.4	
Zero Gate Voltage Drain Current	$I_{DSS}$	$V_{GS}=0V, V_{DS}=100V, T_J=25^{\circ}\text{C}$	-	-	1	$\mu A$
		$V_{GS}=0V, V_{DS}=100V, T_J=100^{\circ}\text{C}$	-	-	100	
Gate to Source Leakage Current	$I_{GSS}$	$V_{GS}=\pm 20V, V_{DS}=0V$	-	-	$\pm 100$	nA
Drain to Source on Resistance	$R_{DS(on)}$	$V_{GS}=10V, I_D=8A$	-	16.5	22	$m\Omega$
		$V_{GS}=4.5V, I_D=6A$	-	20.6	26	
Transconductance	$g_{fs}$	$V_{DS}=5V, I_D=8A$	-	32	-	S
Gate Resistance	$R_G$	$V_{GS}=0V, V_{DS}$ Open, $f=1\text{MHz}$	-	1.5	-	$\Omega$

**Dynamic Characteristics**

Input Capacitance	$C_{iss}$	$V_{GS}=0V, V_{DS}=50V, f=1\text{MHz}$	-	1350	-	pF
Output Capacitance	$C_{oss}$		-	104	-	
Reverse Transfer Capacitance	$C_{riss}$		-	7	-	
Total Gate Charge	$Q_g(10V)$	$V_{DD}=50V, I_D=8A, V_{GS}=10V$	-	19.9	-	nC
Total Gate Charge	$Q_g(4.5V)$		-	8.5	-	
Gate to Source Charge	$Q_{gs}$		-	4.8	-	
Gate to Drain (Miller) Charge	$Q_{gd}$		-	3.0	-	
Turn on Delay Time	$t_{d(on)}$	$V_{DD}=50V, I_D=8A, V_{GS}=10V,$ $R_G=10\Omega,$	-	7	-	ns
Rise time	$t_r$		-	2	-	
Turn off Delay Time	$t_{d(off)}$		-	17	-	
Fall Time	$t_f$		-	2	-	

**Reverse Diode Characteristics**

Diode Forward Voltage	$V_{SD}$	$V_{GS}=0V, I_F=8A$	-	0.9	1.2	V
Reverse Recovery Time	$t_{rr}$	$V_R=50V, I_F=8A, di_F/dt=500A/\mu s$	-	21	-	ns
Reverse Recovery Charge	$Q_{rr}$		-	92	-	nC

Fig 1. Typical Output Characteristics

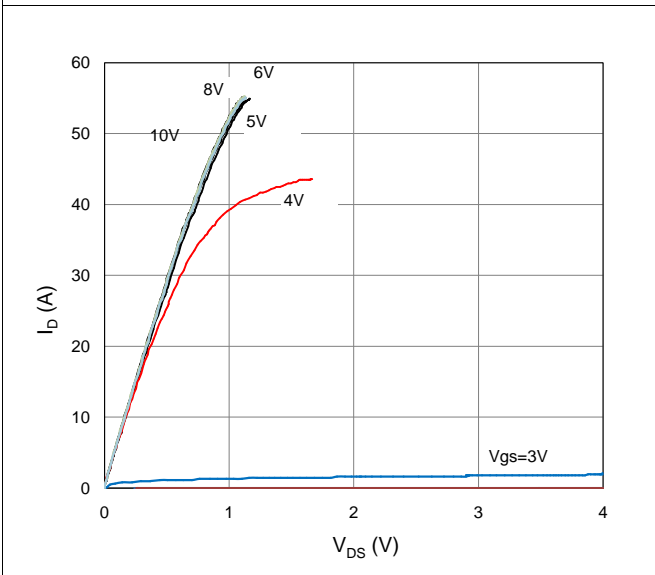

Figure 2. On-Resistance vs. Gate-Source Voltage

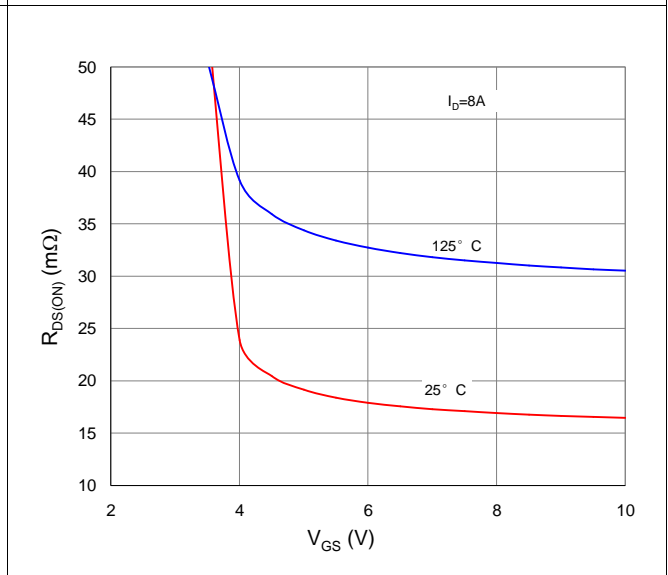

Figure 3. On-Resistance vs. Drain Current and Gate Voltage

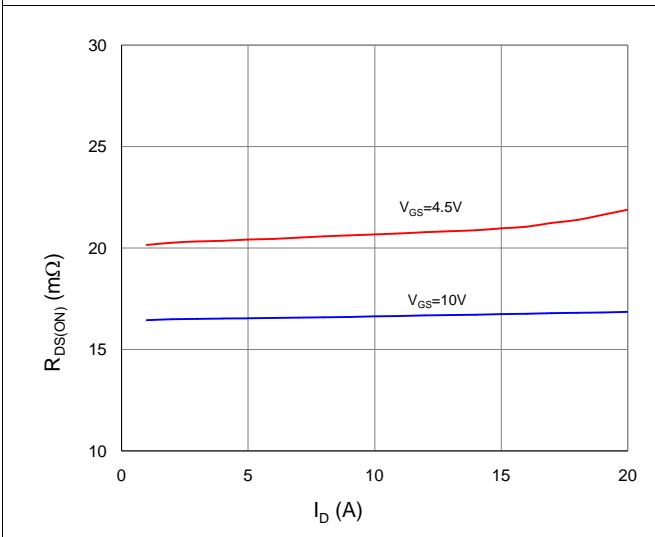

Figure 4. Normalized On-Resistance vs. Junction Temperature

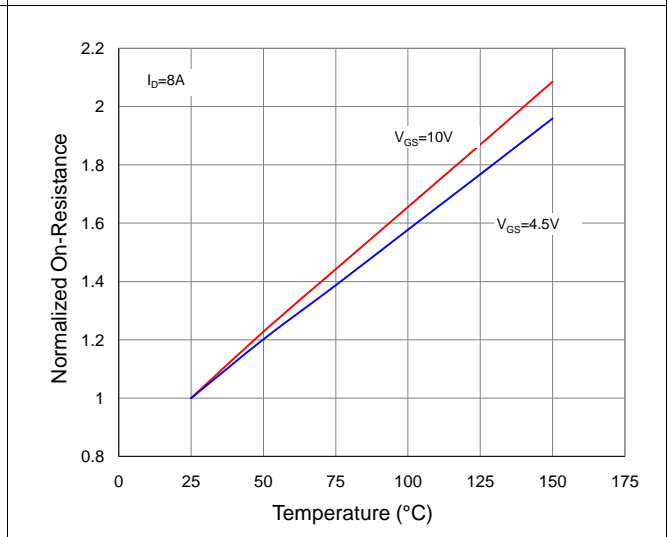

Figure 5. Typical Transfer Characteristics

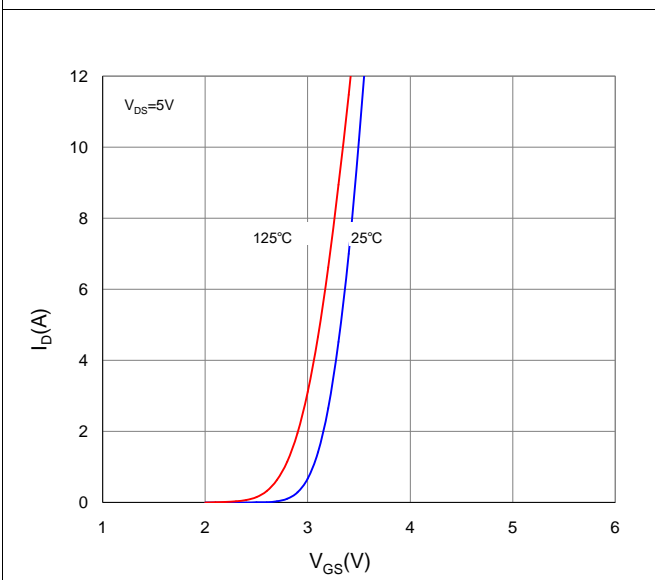

Figure 6. Typical Source-Drain Diode Forward Voltage

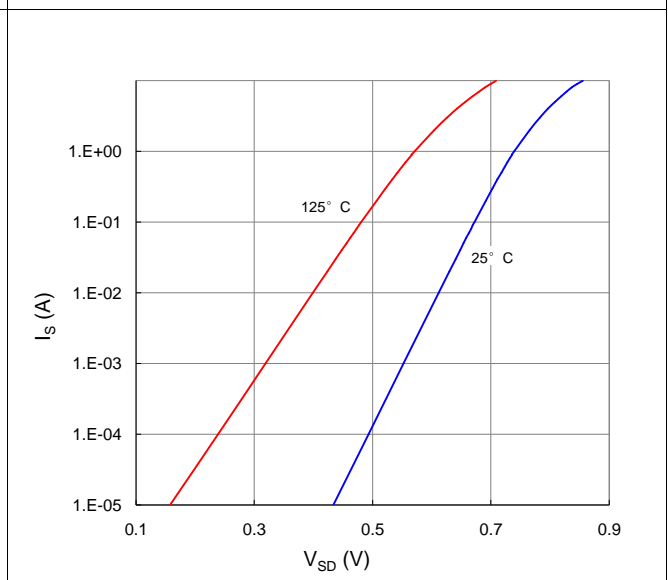

Figure 7. Typical Gate-Charge vs. Gate-to-Source Voltage

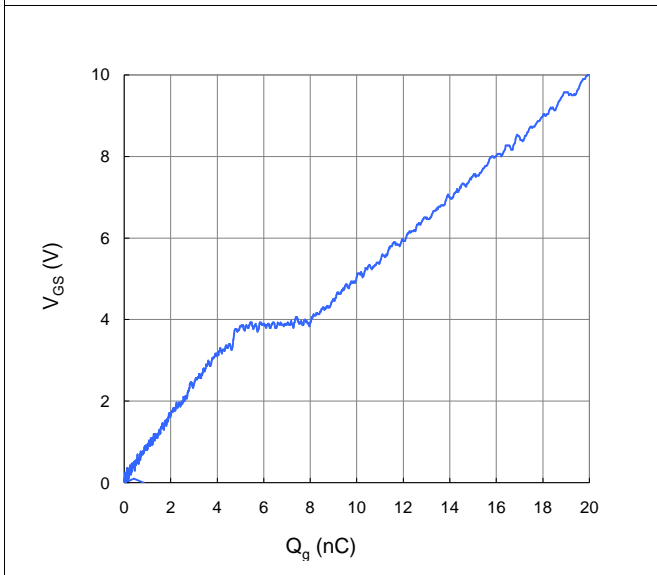

Figure 8. Typical Capacitance vs. Drain-to-Source Voltage

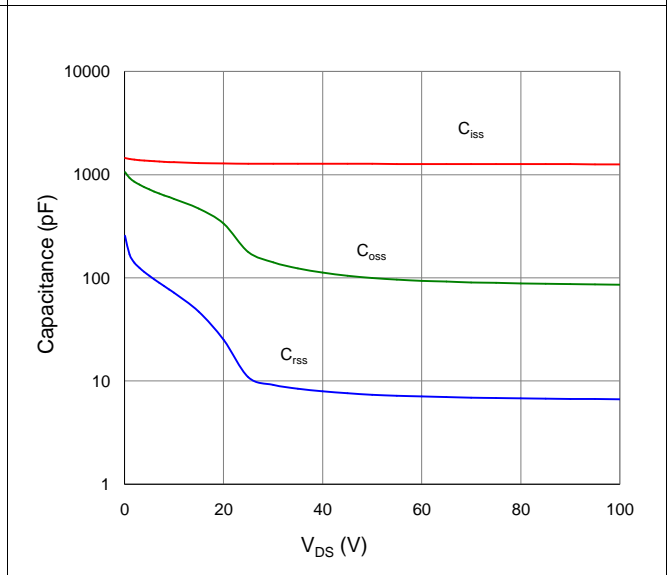

Figure 9. Maximum Safe Operating Area

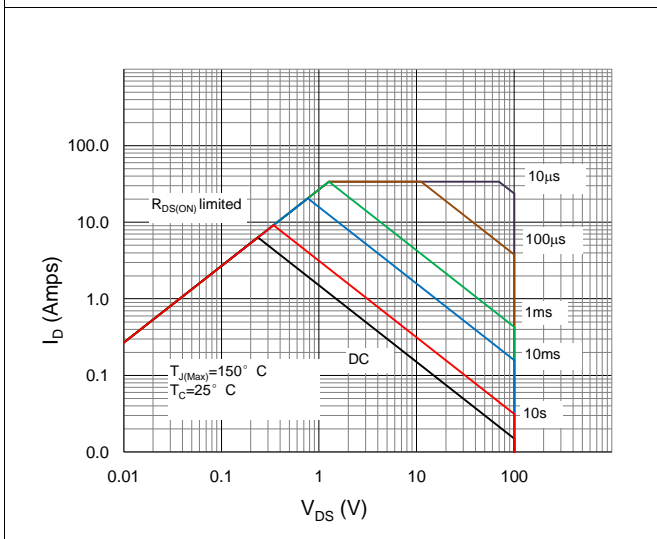

Figure 10. Maximum Drain Current vs. Case Temperature

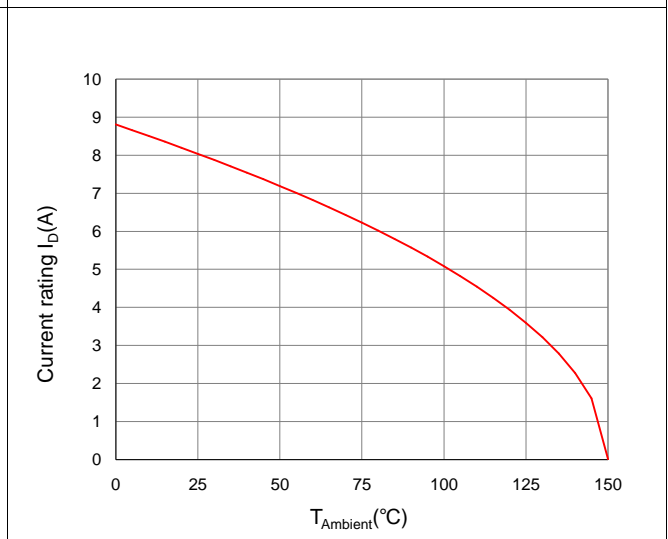
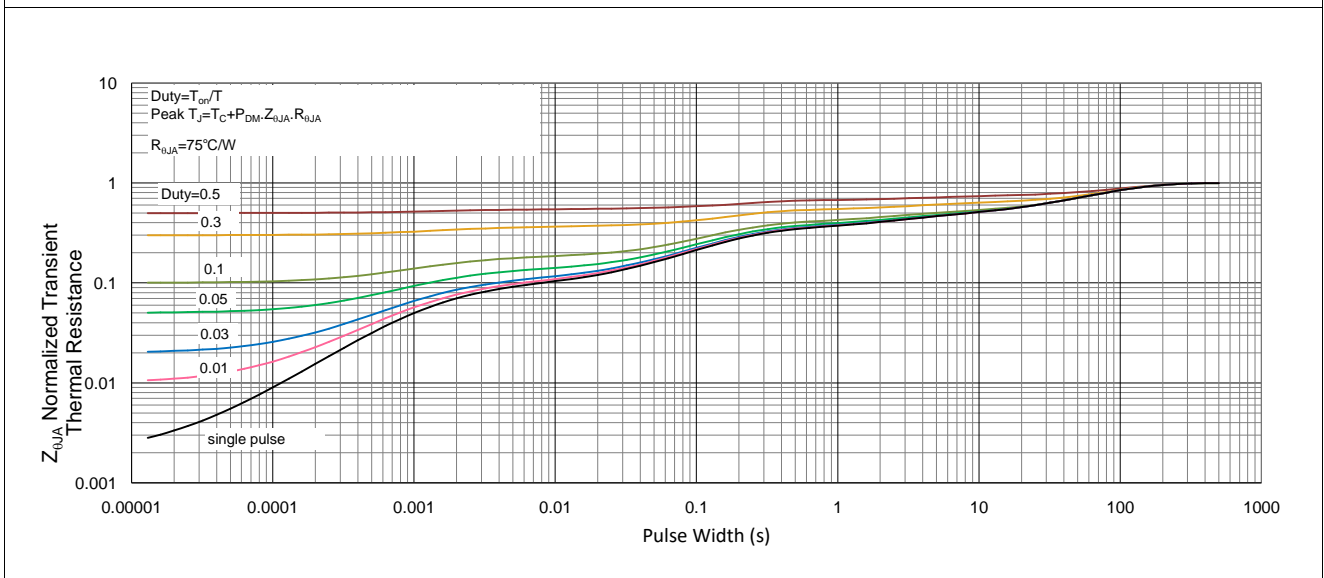
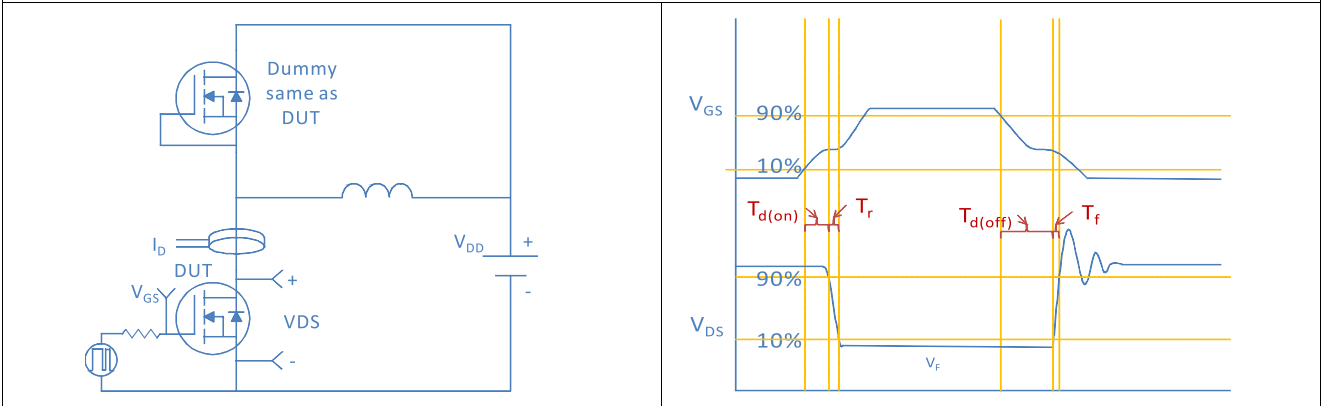

Figure 11. Normalized Maximum Transient Thermal Impedance, Junction-to-Ambient



Inductive switching Test



Gate Charge Test

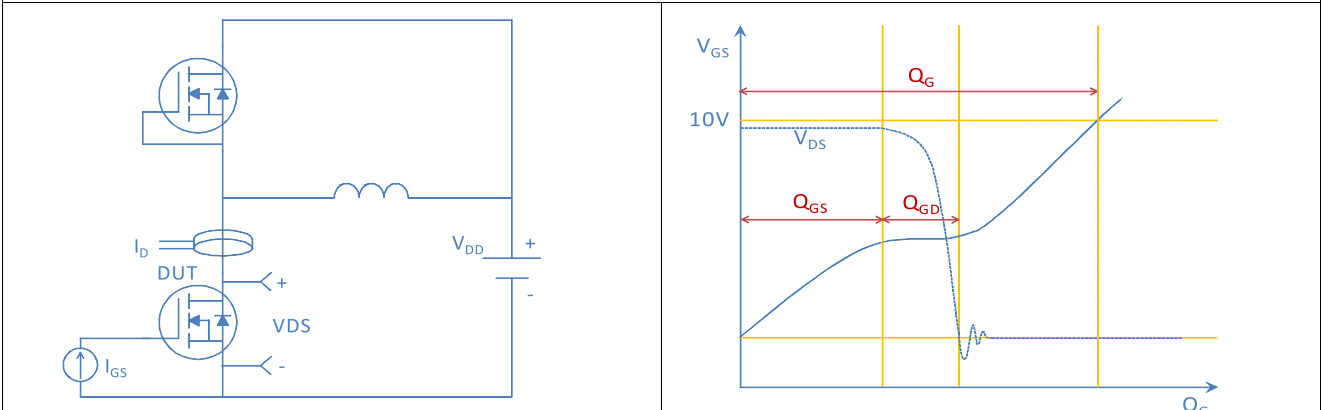

Unclamped Inductive Switching (UIS) Test

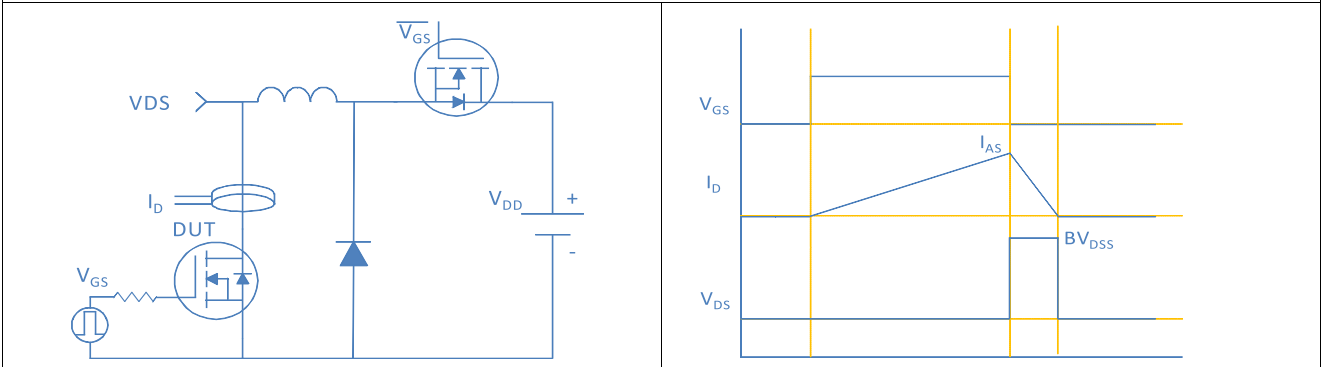

Diode Recovery Test

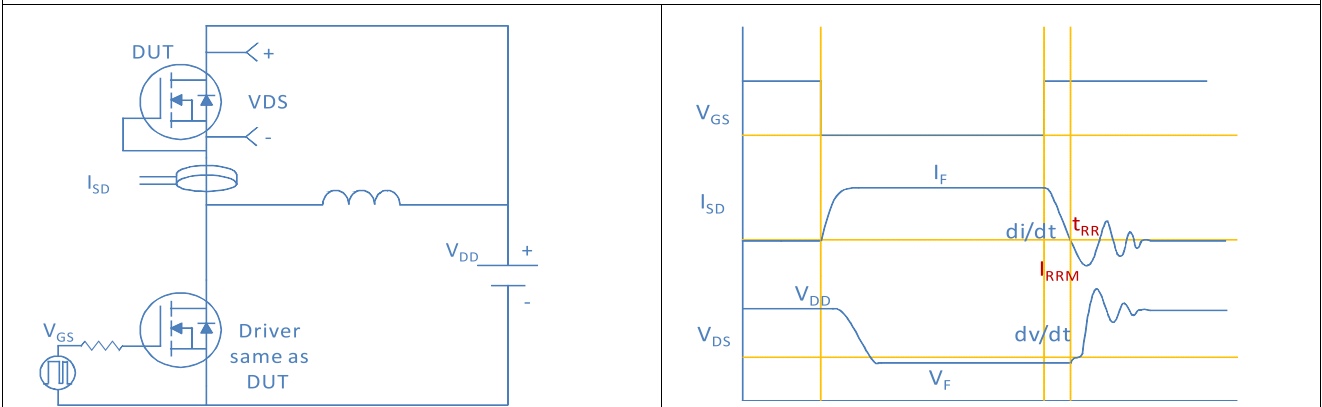

Package Outline

SOIC-8, 8 leads

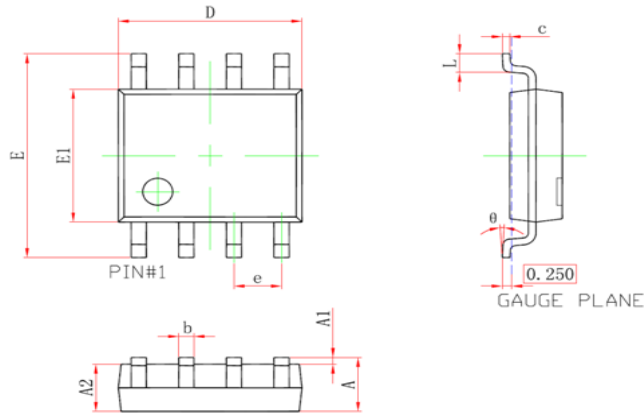

Symbol	Dimensions In Millimeters		Dimensions In Inches	
	Min	Max	Min	Max
A	1.350	1.750	0.053	0.069
A1	0.100	0.250	0.004	0.010
A2	1.250	1.650	0.049	0.065
b	0.310	0.510	0.012	0.020
c	0.170	0.250	0.007	0.010
D	4.800	5.000	0.189	0.197
e	1.270 (BSC)		0.050 (SBC)	
E	5.800	6.200	0.228	0.244
E1	3.800	4.000	0.150	0.157
L	0.400	1.270	0.016	0.031
theta	0°	8°	0°	8°